

PRODUCT SPECIFICATIONS

Elkay Lustertone™ Classic Stainless Steel 15" x 17-1/2" x 10", Single Bowl Drop-in Sink. Sink is manufactured from 18 gauge 304 Stainless Steel with a Lustrous Satin finish, Center drain placement, and Sides and Bottom pads.

Installation Type:	Drop-in
Material:	304 Stainless Steel
Finish:	Lustrous Satin
Gauge:	18
Sound Deadening:	Sides and Bottom pads
Number of Bowls:	1
Sink Dimensions:	15" x 17-1/2" x 10"
Bowl 1 Dimensions:	12" x 12" x 9-7/8"
Drain Size:	3-1/2" (89mm)
Drain Location:	Center
Minimum Cabinet Size:	18"
Mounting Hardware:	Part # 64090010 included for countertops up to 3/4" (19mm) thick
Template Included:	No
Cutout Template #:	1000001273

Template is available for download at elkay.com. CAD software will be required to open the template.

Cutout Dimensions for Drop-in Installation:

14-3/8" x 16-7/8" (365mm x 429mm) with 1-1/2" (38mm) corner radius

Custom Options	
<input type="checkbox"/> Type 316 Stainless Steel	
Drain Location	
<input type="checkbox"/> Right Rear	<input type="checkbox"/> Left Rear
<input type="checkbox"/> Center	<input type="checkbox"/> Center Rear
Overflow Location	
<input type="checkbox"/> Front	<input type="checkbox"/> Rear
Alternate Punching	
<input type="checkbox"/> Faucet Model:	<input type="checkbox"/> Punch Required:
Sink Size	
<input type="checkbox"/> Bowl Depth:	<input type="checkbox"/> Drainboard Width:



A Century of Tradition and Quality.

For more than 100 years, Elkay has been making innovative products and providing exceptional customer care. We take pride in offering plumbing products that make life easier, inspire change and leave the world a better place.



Product Compliance: ASME A112.19.3/CSA B45.4
Buy American Act



Sinks are listed by IAPMO® as meeting the applicable requirements of the Uniform Plumbing Code®, International Plumbing Code®, and National Plumbing Code of Canada.

[Clean and Care Manual \(PDF\)](#)
[Installation Instructions \(PDF\) - 1000005236](#)
[Warranty \(PDF\)](#)

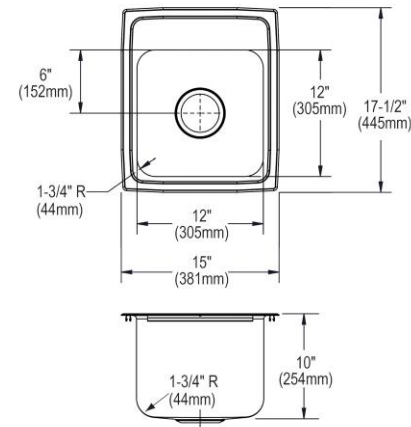

PART: _____ QTY: _____

PROJECT: _____

CONTACT: _____

DATE: _____

NOTES: _____

APPROVAL: _____

In keeping with our policy of continuing product improvement, Elkay reserves the right to change product specifications without notice. Please visit elkay.com for the most current version of Elkay product specification sheets. This specification describes an Elkay product with design, quality, and functional benefits to the user. When making a comparison of other producers' offerings, be certain these features are not overlooked.



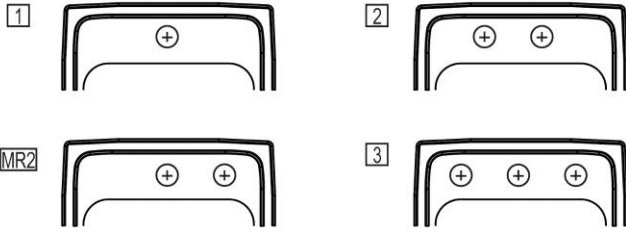

Hole Drilling Configurations:

1-1/2" (38mm) Diameter Faucet Holes on 4" (102mm) Centers



Installation Profile:



Optional Accessories		
CB912	Elkay Hardwood 12-7/8" x 10-1/8" x 1" Cutting Board Spec Sheet (PDF)	
LK99	Elkay Deluxe 3-1/2" Drain Type 304 Stainless Steel Body Strainer Basket Rubber Seal and Tailpiece Spec Sheet (PDF)	
LKGT1042CR	Elkay Gourmet Single Hole Bar Faucet Pull-out Spray and Lever Handle Chrome Spec Sheet (PDF)	
LKGT1042NK	Elkay Gourmet Single Hole Bar Faucet Pull-out Spray and Lever Handle Brushed Nickel Spec Sheet (PDF)	
LKGT1042RB	Elkay Gourmet Single Hole Bar Faucet Pull-out Spray and Lever Handle Oil Rubbed Bronze Spec Sheet (PDF)	

In keeping with our policy of continuing product improvement, Elkay reserves the right to change product specifications without notice. Please visit elkay.com for the most current version of Elkay product specification sheets. This specification describes an Elkay product with design, quality, and functional benefits to the user. When making a comparison of other producers' offerings, be certain these features are not overlooked.

LKWRB1209SS	Elkay Stainless Steel 8" x 11" x 7" Rinsing Basket Spec Sheet (PDF)	
-----------------------------	--	---

In keeping with our policy of continuing product improvement, Elkay reserves the right to change product specifications without notice. Please visit elkay.com for the most current version of Elkay product specification sheets. This specification describes an Elkay product with design, quality, and functional benefits to the user. When making a comparison of other producers' offerings, be certain these features are not overlooked.